

Bolt Circle for NEMA motors

Shaft	Universal Bracket	
	MIN	MAX
0.625"	4.575"	5.375"
0.875"	4.825"	5.625"
1.125"	5.075"	5.875"
1.375"	5.325"	6.125"
1.625"	5.575"	6.375"
1.875"	5.825"	6.625"
2.125"	6.075"	6.875"
2.375"	6.325"	7.125"
2.875"	6.825"	7.625"
3.375"	7.325"	8.125"
3.625"	7.575"	8.375"
3.875"	7.825"	8.625"
4.375"	8.325"	9.125"
4.875"	8.825"	9.625"

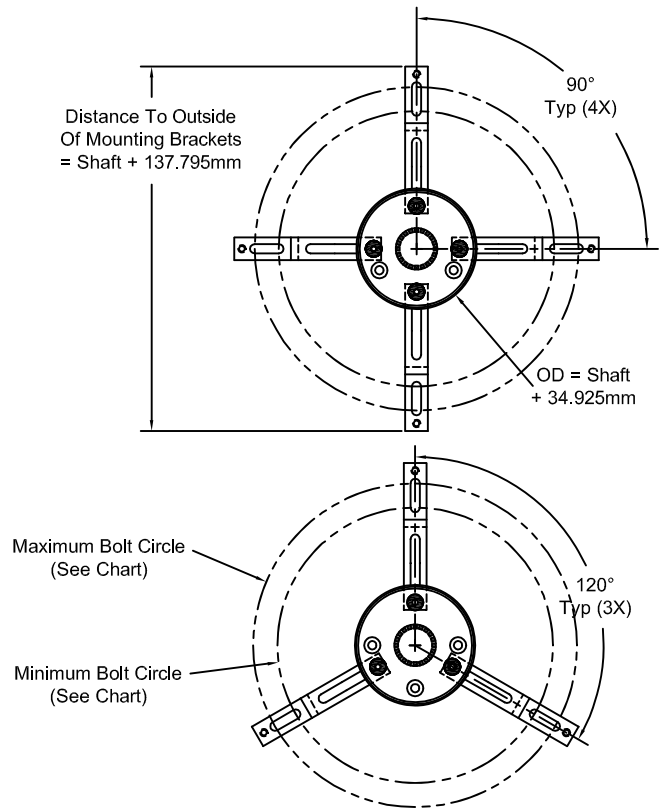

Patented Technology
www.est-aegis.com

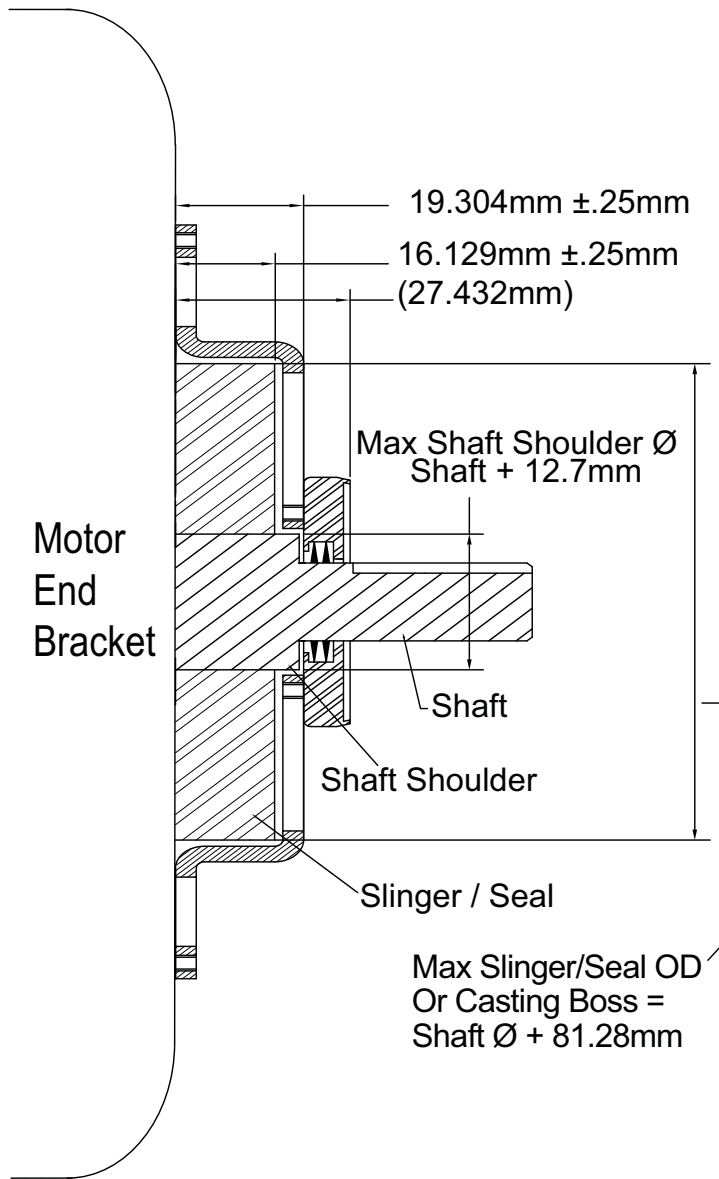

Bolt Circle for IEC motors

Shaft	Universal Bracket	
	MIN	MAX
28	129mm	148mm
38	139mm	158mm
42	143mm	162mm
48	149mm	168mm
55	156mm	175mm
60	161mm	180mm
65	166mm	185mm
70	171mm	190mm
75	176mm	195mm
80	181mm	200mm
85	186mm	205mm
90	191mm	210mm
95	196mm	215mm



Patented Technology
www.est-aegis.com