

Not Drawn to Scale

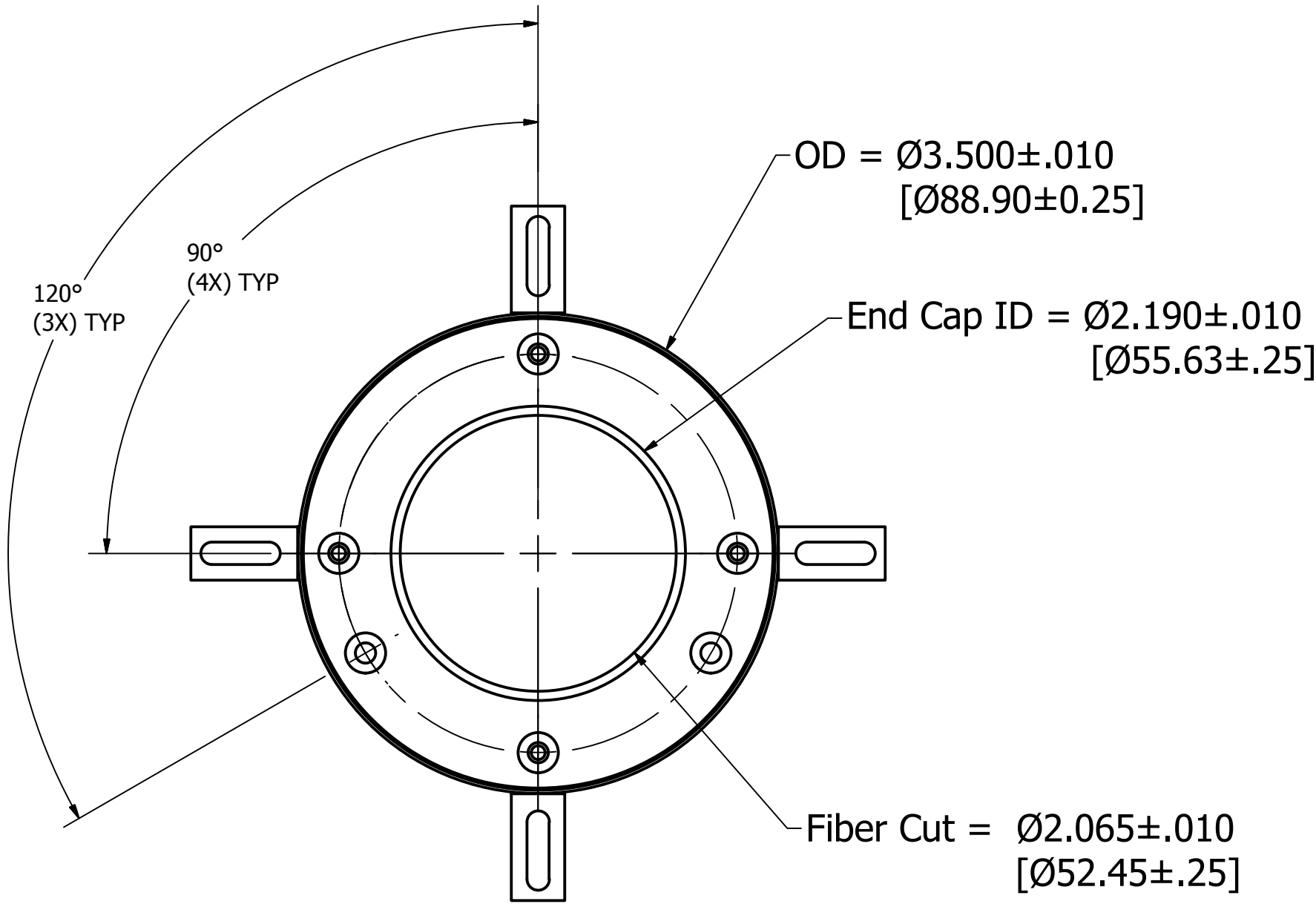

Bracket Shown on Drawing

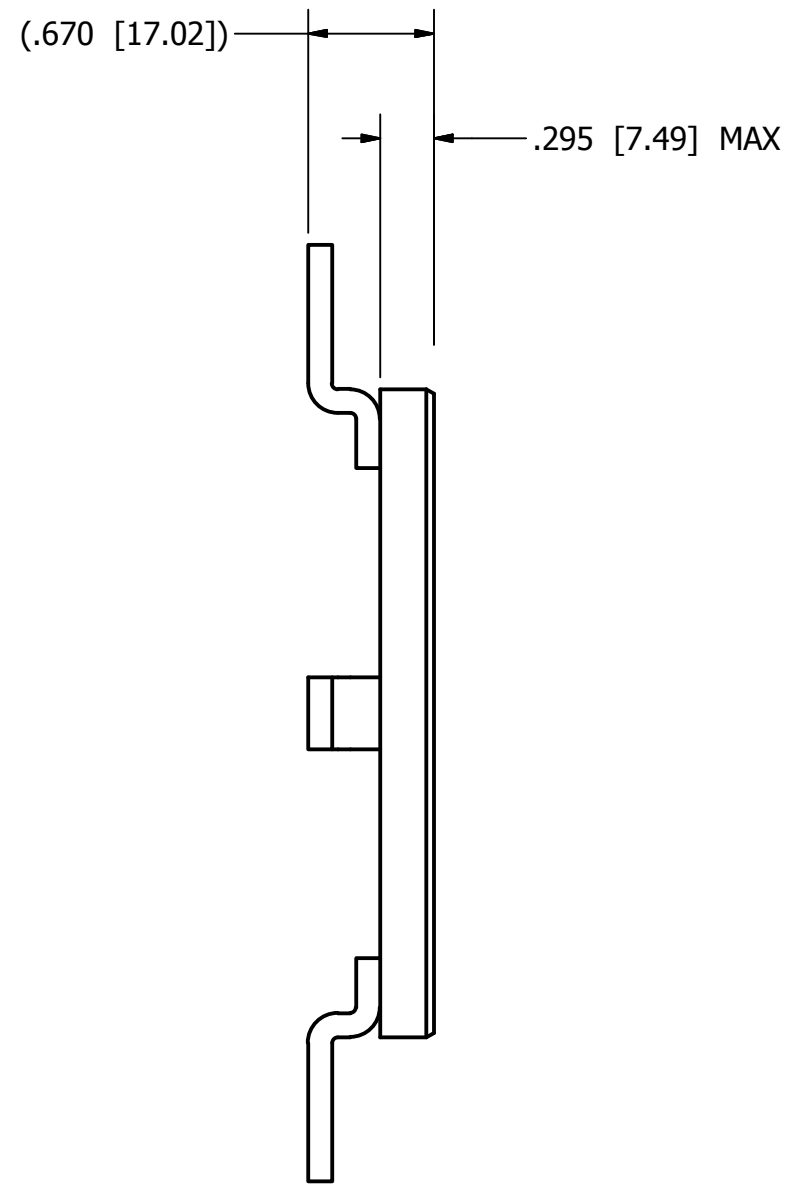
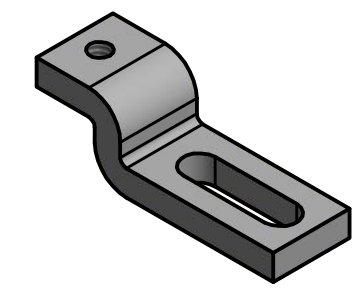

A-97000-18

Mtg Bolt Circle: Ø3.900 -- Ø4.700
[Ø99.06] [Ø119.38]

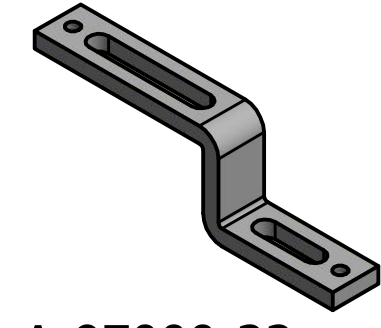

A-97000-22
(Reversible)

Mtg Bolt Circle: Ø5.200 (normal) -- Ø6.875 [Ø132.08] [Ø174.63]

Mtg Bolt Circle: Ø6.075 (reversed) -- Ø6.875 [Ø154.31] [Ø174.63]

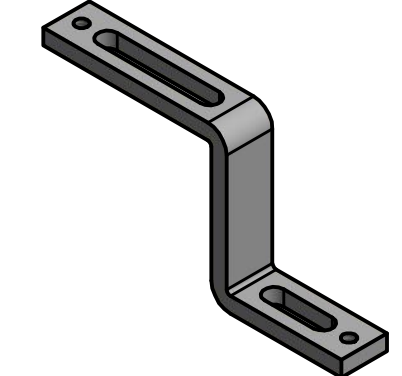

A-97000-23
(Reversible)

Mtg Bolt Circle: Ø5.200 (normal) -- Ø6.875 [Ø132.08] [Ø174.63]

Mtg Bolt Circle: Ø6.075 (reversed) -- Ø6.875 [Ø154.31] [Ø174.63]

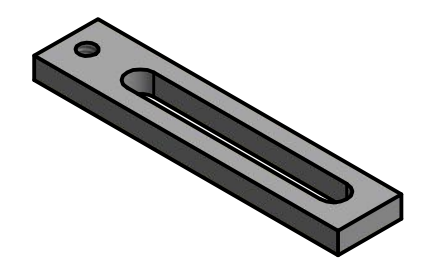

A-97000-20

Mtg Bolt Circle: Ø3.950 -- Ø5.825
[Ø100.33] [Ø147.96]

Notes:

- AEGIS SGR-2.125-UKIT Includes
- (1) AEGIS SGR Bearing Protection Ring
 - (4) Universal brackets Of Each size (16 total)
 - (4) 5-40 x 3/8 Flat Head Cap Screws
 - (4) 6-32 x 3/8 Socket Head Cap Screws
 - (4) #6 Flat Washers
 - (4) #6 Split Lock Washers
 - 5/64" Allen Wrench
 - 7/64" Allen Wrench

Patented Technology US Patent 8,199,453; 8,169,766; 7,193,836

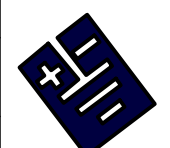
THEREIN, ARE THE EXCLUSIVE PROPERTY OF ELECTRO STATIC TECHNOLOGY ISSUED IN STRICT CONFIDENCE AND SHALL NOT WITHOUT CONSENT, BE REPRODUCED, COPIED OR USED FOR ANY PURPOSE WHATSOEVER, EXCEPT BUSINESS WITH E.S.T.	
UNLESS OTHERWISE SPECIFIED DIMENSIONS ARE IN: inch [mm]	 ELECTRO STATIC TECHNOLOGY AN ITW COMPANY
UNTOLERANCED DIMENSIONS ± .020 [0.5mm]	
DATE: 5/2/2017	31 WINTERBROOK ROAD, MECHANIC FALLS, MAINE 04256 PHONE (207)998-5140 FAX (207)998-5143
ENGINEER: A. Gen	To Suit 2.125" Shaft Diameter PART NUMBER: SGR-2.125-UKIT REV A