

Not Drawn to Scale

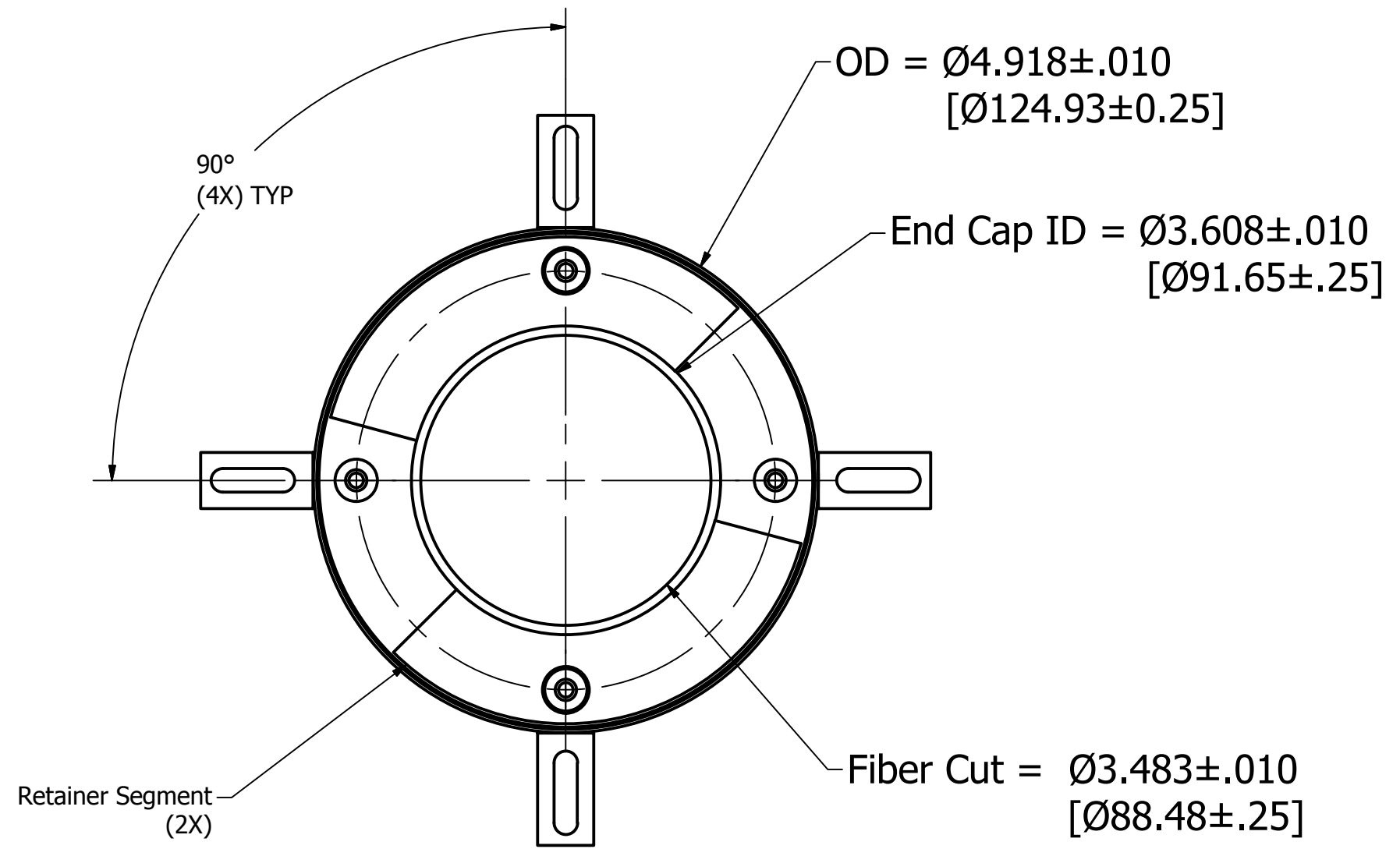

Bracket Shown on Drawing

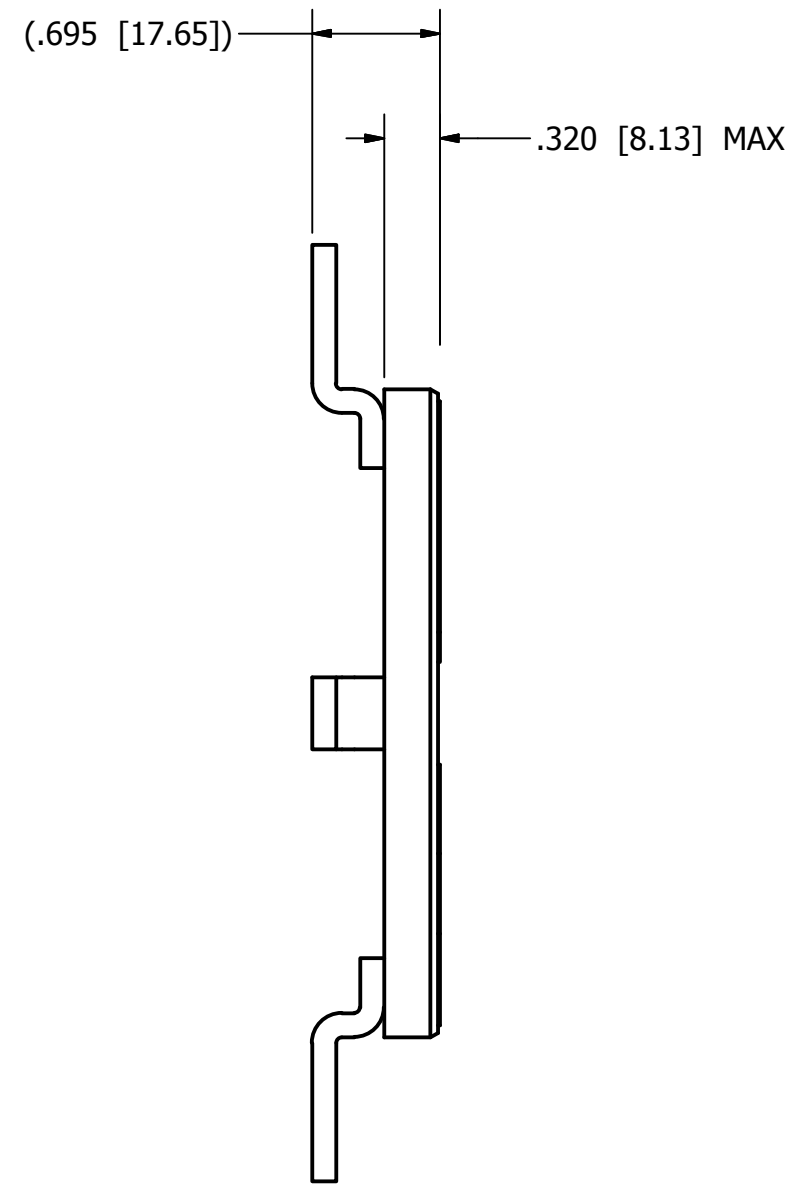

A-97000-18

Mtg Bolt Circle: Ø5.318 -- Ø6.118  
[Ø135.09] [Ø155.41]



A-97000-22  
(Reversible)

Mtg Bolt Circle: Ø6.618 (normal) -- Ø8.293 [Ø168.11] [Ø210.65]

Mtg Bolt Circle: Ø7.493 (reversed) -- Ø8.293 [Ø190.33] [Ø210.65]



A-97000-23  
(Reversible)

Mtg Bolt Circle: Ø6.618 (normal) -- Ø8.293 [Ø168.11] [Ø210.65]

Mtg Bolt Circle: Ø7.493 (reversed) -- Ø8.293 [Ø190.33] [Ø210.65]



A-97000-20

Mtg Bolt Circle: Ø5.368 -- Ø7.243 [Ø136.36] [Ø183.98]

Notes:

AEGIS SGR-90.0-UKIT-2A4 Includes

- (1) AEGIS SGR Bearing Protection Ring
- (4) Universal brackets Of Each size (16 total)
- (4) 5-40 x 3/8 Flat Head Cap Screws
- (4) M4 x .7 x 10mm Socket Head Cap Screws
- (4) M4 Flat Washers
- (4) M4 Split Lock Washers
- 5/64" Allen Wrench
- 3mm Allen Wrench

Patented Technology US Patent 8,199,453; 8,169,766; 7,193,836

THEREIN, ARE THE EXCLUSIVE PROPERTY OF ELECTRO STATIC TECHNOLOGY ISSUED IN STRICT CONFIDENCE AND SHALL NOT WITHOUT CONSENT, BE REPRODUCED, COPIED OR USED FOR ANY PURPOSE WHATSOEVER, EXCEPT BUSINESS WITH E.S.T.

UNLESS OTHERWISE SPECIFIED  
DIMENSIONS ARE IN:  
inch [mm]

UNTOLERANCED DIMENSIONS  
± .020 [0.5mm]

DATE: 5/3/2017

ENGINEER: A. Gen

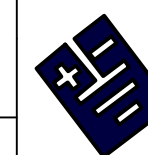

ELECTRO STATIC TECHNOLOGY  
AN ITW COMPANY

31 WINTERBROOK ROAD, MECHANIC FALLS, MAINE 04256  
PHONE (207)998-5140 FAX (207)998-5143

To Suit 90mm Shaft Diameter

PART NUMBER: SGR-90.0-UKIT-2A4

REV A